

FIG.2

CONVENTION ART

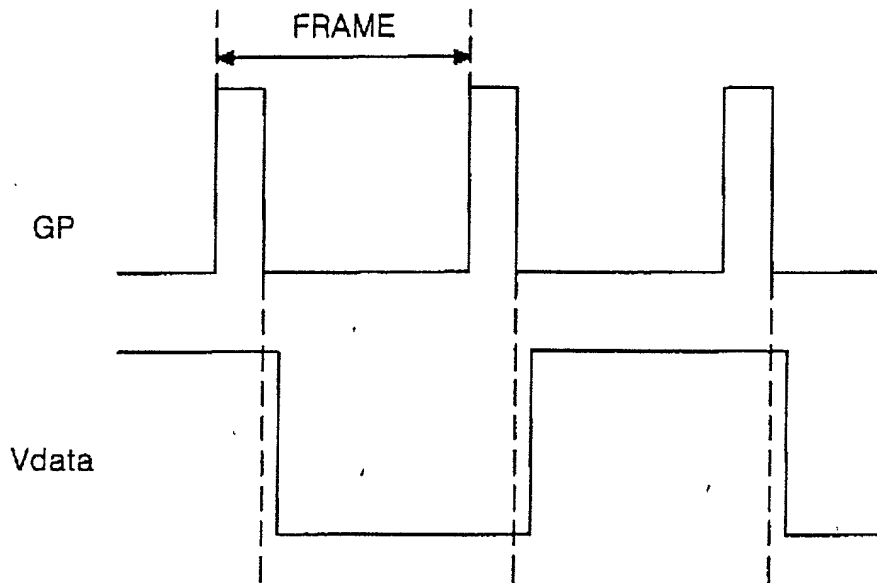
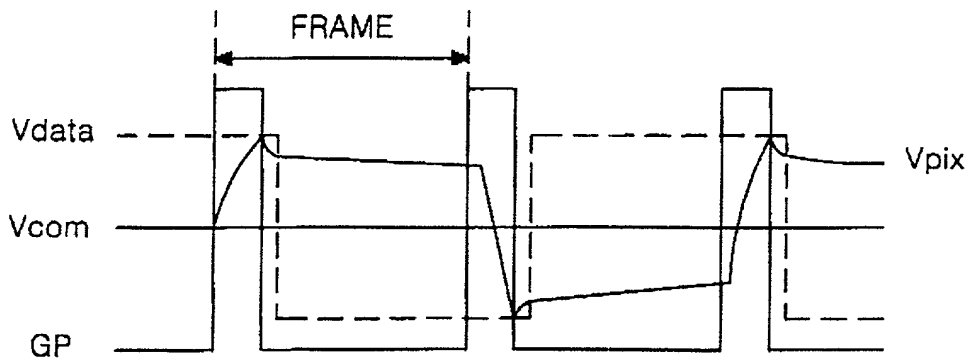

FIG.3

CONVENTION ART



OFF 64852/60

FIG.4
CONVENTIONAL ART

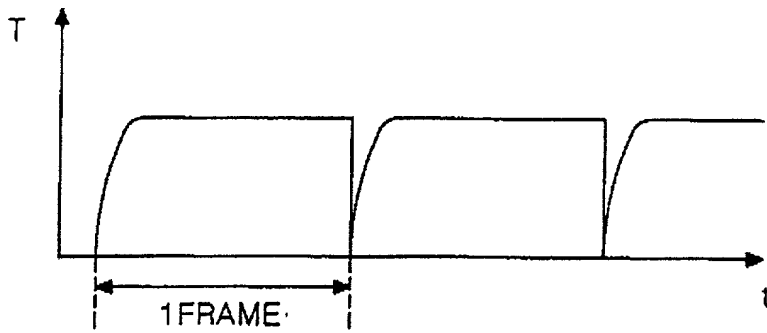

FIG.5

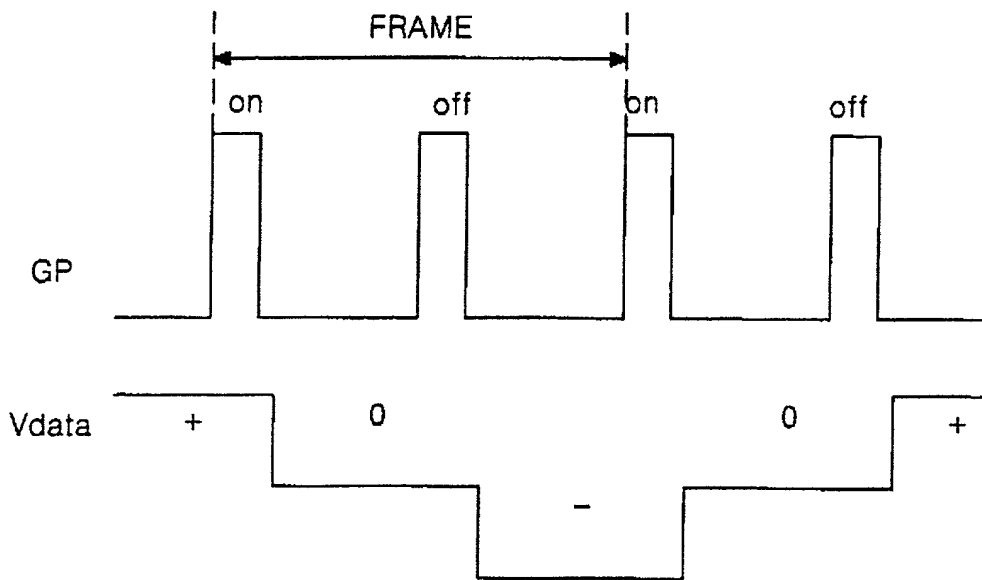

FIG.6

Vpolarity1	+		-		+		-	
Vpolarity2	+	0	-	0	+	0	-	0

FIG.7

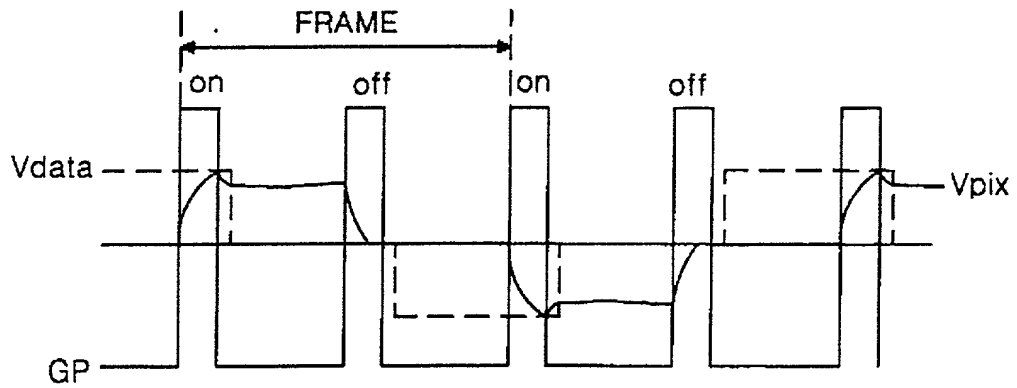

FIG. 8

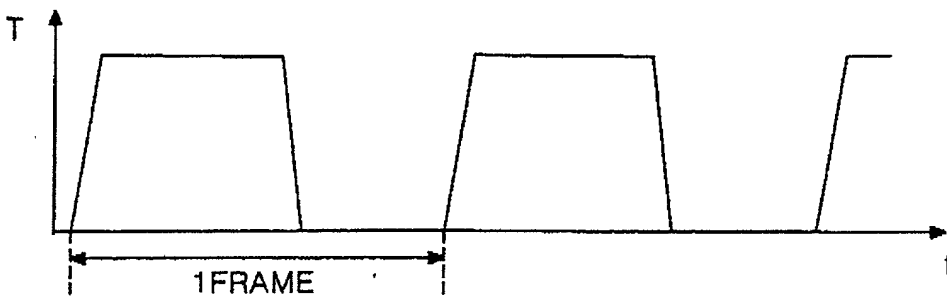

FIG. 9

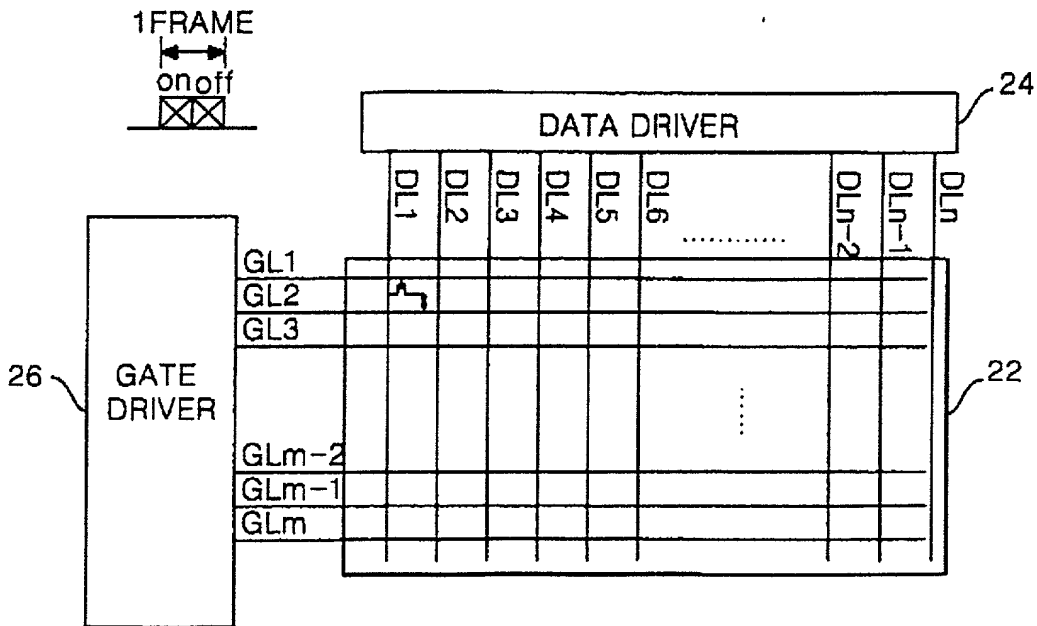

FIG.10

26

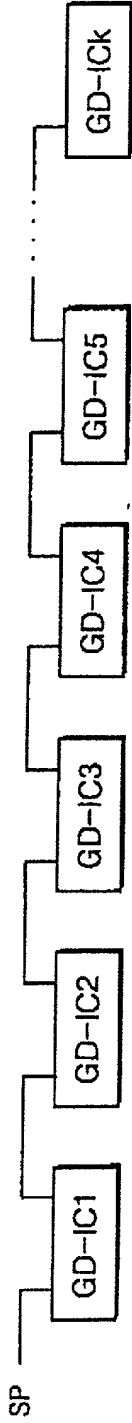

FIG.11

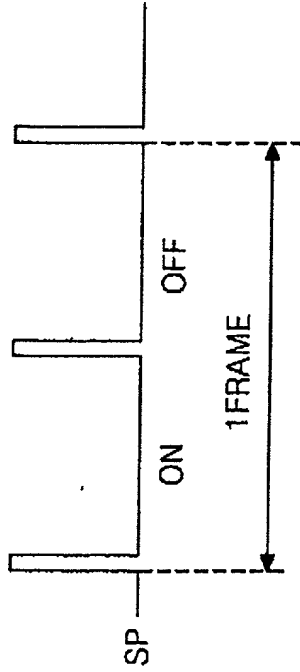
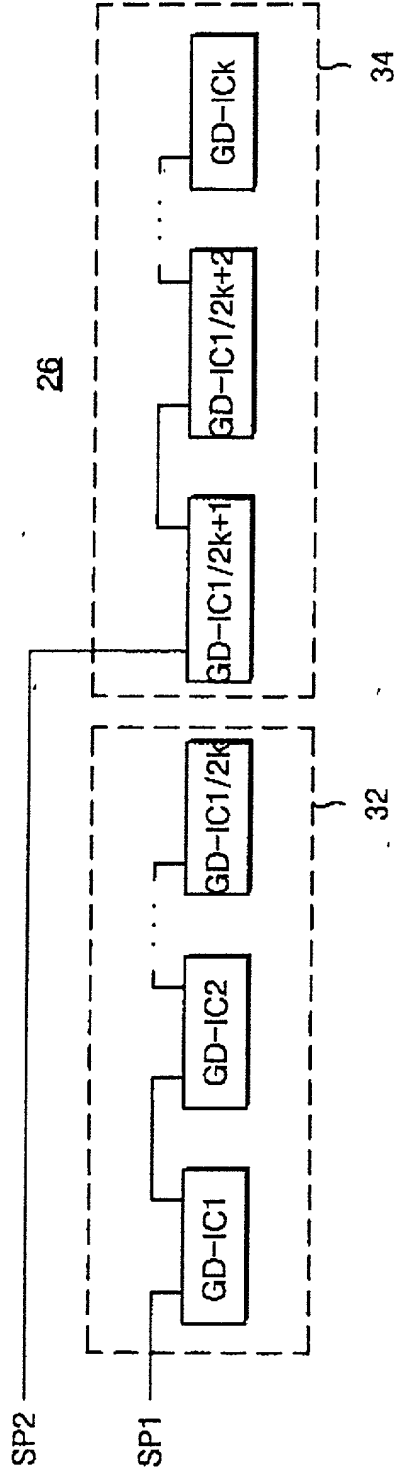
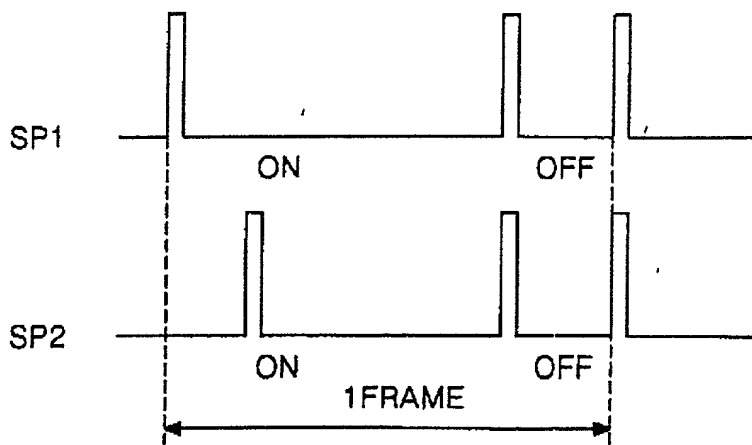

FIG.12



00000000

FIG.13



00000000

FIG. 14

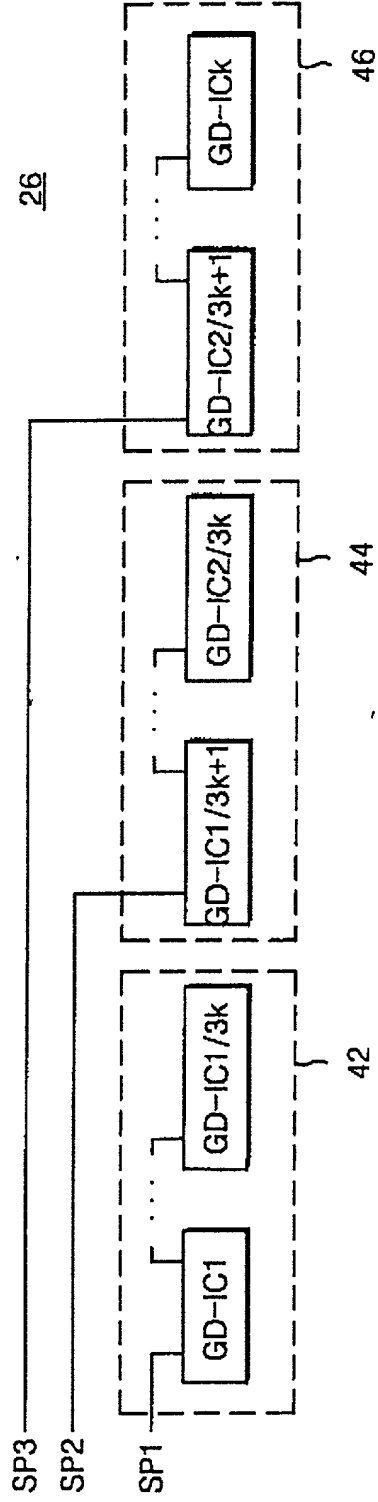

FIG.15

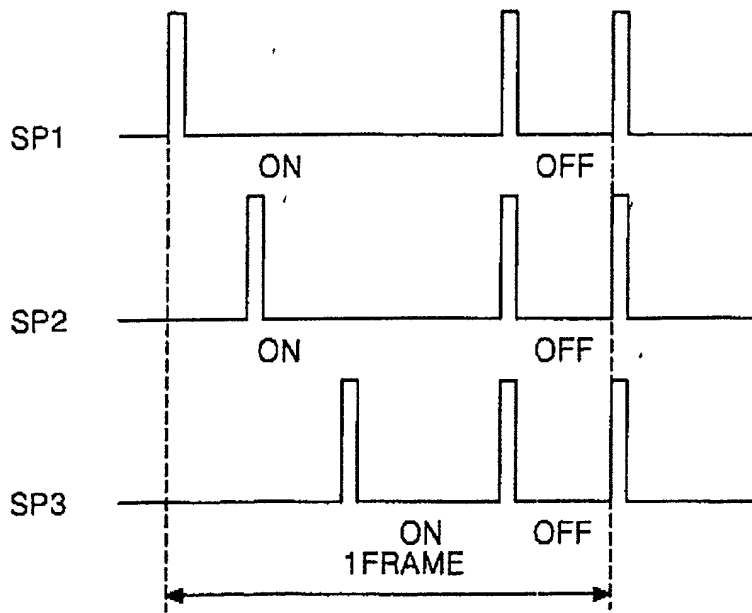

FIG.16

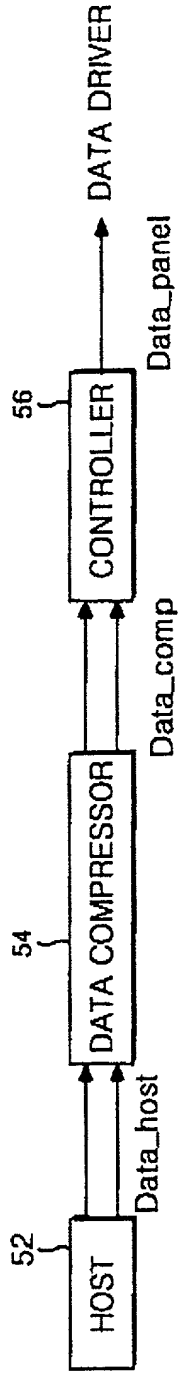
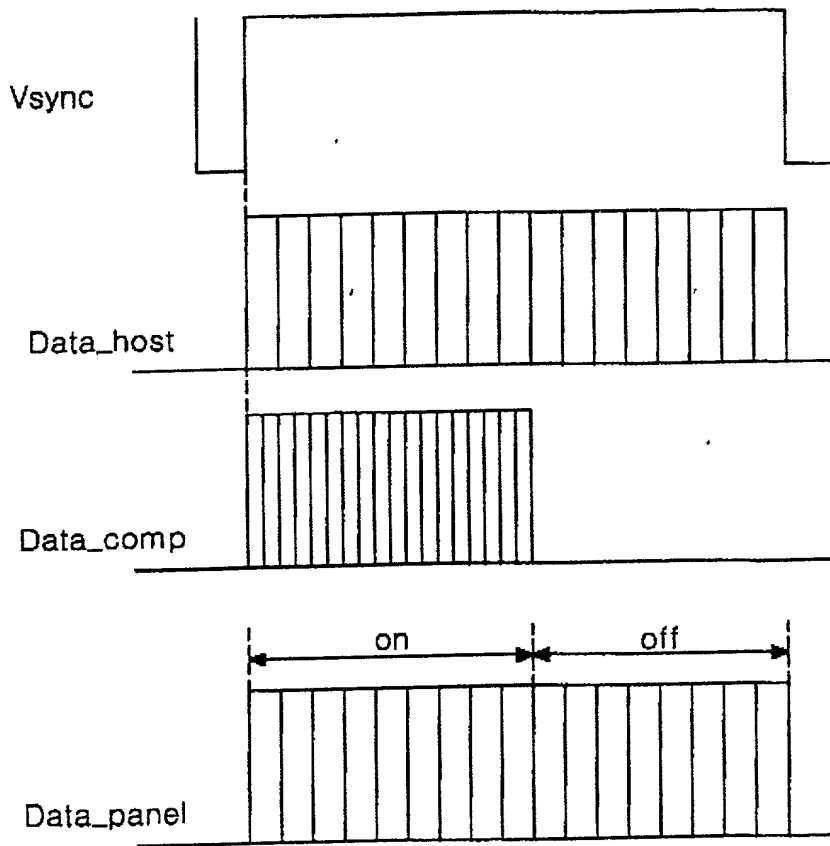

FIG.17



00000000 00000000 00000000 00000000

FIG.18

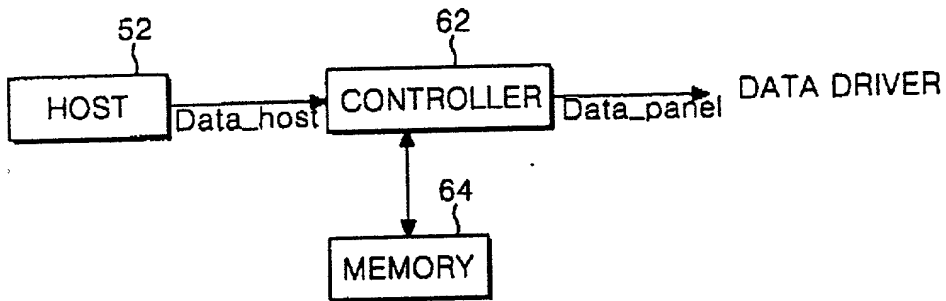

FIG.19

